

V.50











Applications

Roads and highways, parking lots and large areas, roundabouts, pedestrian and bicycle paths, pedestrian crossing.

Fixing

· Post top with flange with 50 mm Ø central hole for fixing the lantern to the support

Materials

- Die-cast aluminum housing
- Die-cast polycarbonate screen
- Stainless steel fasteners
- Silicone gasket between top and bottom parts

Finishes - powder coating

- Alcea Apex Black
- Alcea Apex Grey
- Could be painted in any chosen color in RAL

Recommended installation height	from 4 to 6 m
Size	510x345 mm
IP	65
Supply voltage	220-240V
Electrical insulation	Class I, II
Power factor correction	PFC > cos φ 0.9

Family V.50

Post top

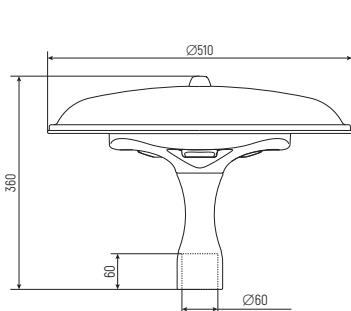

V.50-01

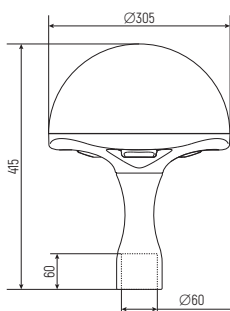

V.50-02

Main LED data



ENCLOSURE PROTECTION Electrical auxiliaries

- Programmable electronic power supply with functions: DALI, 1-10V
- Terminals wires max. section of 2.5 mm²
- Surge protection for differential/common mode up to 10kV

Power supply

- Estimated life (L85 – Ta 25°C): >100,000h

SUPPLY VOLTAGE

220V-240V, 50/60Hz frequency

SURGE PROTECTION

10kV/10kV

POWER SUPPLY

Programmable electronic

POWER FACTOR CORRECTION

PFC > cos φ 0.9

ELECTRICAL INSULATION

Class II

ENCLOSURE PROTECTION

Water and dust IP65

DALI, 1-10V

With the two-way digital DALI protocol lighting levels can be adjusted, consumption and system diagnostics monitored. By the analog signal 1-10V, the illumination levels regulation is enabled. Inside the products on the cabling board, space has been made to accommodate an electronic unit for remote management functionalities.

The optical system is composed of overlapping PMMA lenses with high performance and constant light transmission.

V.50 is equipped with highly efficient latest generation of LED Cree XP-L2 positioned on a ceramic base to provide high thermal conductivity and electrical insulation for a longer service life.

Flux sizes option

2700K	1785lm	15W	119lm/W
2700K	3132lm	27W	116lm/W
2700K	4972lm	44W	113lm/W
2700K	6728lm	58W	116lm/W
3000K	1935lm	15W	129lm/W
3000K	3402lm	27W	126lm/W
3000K	5412lm	44W	123lm/W
3000K	7308lm	58W	126lm/W
4000K	2085lm	15W	139lm/W
4000K	3672lm	27W	136lm/W
4000K	5852lm	44W	133lm/W
4000K	7888lm	58W	136lm/W

Photometric light distribution

Type 9

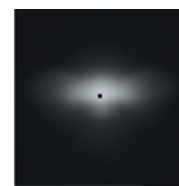
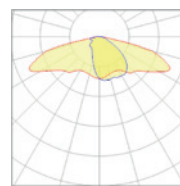

Type 10

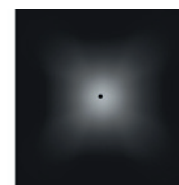
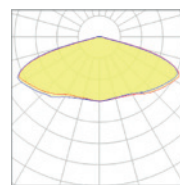

Type 11

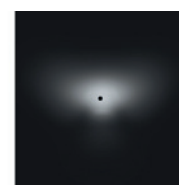
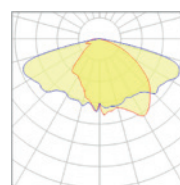

Type 12

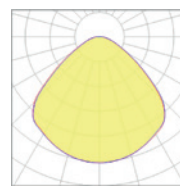

Type 13

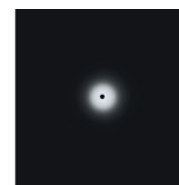
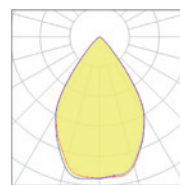

Type 14

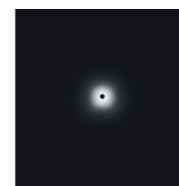
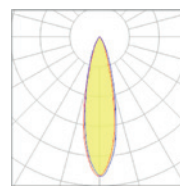

Type 15

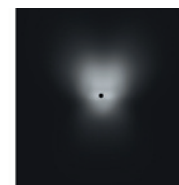
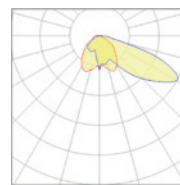

Type 16

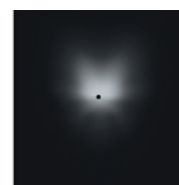
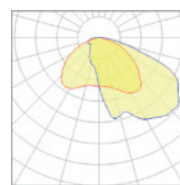

Materials. "ArchiMet" has launched its own production of seamless steel conical production line by induction heating. Laser-cut door with a special lock. Hot-Galvanized. Pole thickness 5mm. The luminaire is made of die-cast aluminium.

Finishes. The standard colors are Apex Grey and Apex Black that are obtained from a chromatic combination, which has been developed after a long aesthetic research. Power coating for luminaire and liquid for the post.

