

V.51







### Applications

Roads and highways, parking lots and large areas, roundabouts, pedestrian and bicycle paths, pedestrian crossing.

### Fixing

· Side mounting with flange with Ø50mm  
3 central holes for fixing the lantern to the support

### Materials

- Die-cast aluminum housing
- Die-cast polycarbonate screen
- Stainless steel fasteners
- Silicone gasket between top and bottom parts

### Finishes - powder coating

- Alcea Apex Black
- Alcea Apex Grey
- Could be painted in any chosen color in RAL

Recommended installation height	from 4 to 8 m
Size	300x285 mm
IP	65
Supply voltage	220-240V
Electrical insulation	Class I, II
Power factor correction	PFC > cos $\varphi$ 0.9

## Family V.51

### Side mounting

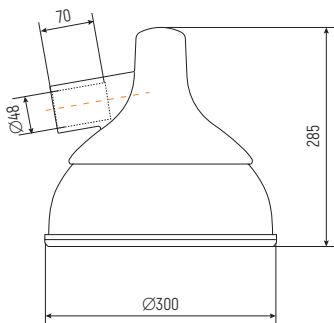

V.51

## Main LED data



### ENCLOSURE PROTECTION Electrical auxiliaries

- Programmable electronic power supply with functions: DALI, 1-10V
- Terminals wires max. section of 2.5 mm<sup>2</sup>
- Surge protection for differential/common mode up to 10kV

### Power supply

- Estimated life (L85 – Ta 25°C): >100,000h

### SUPPLY VOLTAGE

220V-240V, 50/60Hz frequency

### SURGE PROTECTION

10kV/10kV

### POWER SUPPLY

Programmable electronic

### POWER FACTOR CORRECTION

PFC > cos φ 0.9

### ELECTRICAL INSULATION

Class II

### ENCLOSURE PROTECTION

Water and dust IP65

DALI, 1-10V

With the two-way digital DALI protocol lighting levels can be adjusted, consumption and system diagnostics monitored. By the analog signal 1-10V, the illumination levels regulation is enabled. Inside the products on the cabling board, space has been made to accommodate an electronic unit for remote management functionalities.

The optical system is composed of overlapping PMMA lenses with high performance and constant light transmission.

V.51 is equipped with highly efficient latest generation of LED Cree XP-L2 positioned on a ceramic base to provide high thermal conductivity and electrical insulation for a longer service life.

### Flux sizes option

2700K	3132lm	27W	116lm/W
2700K	4972lm	44W	113lm/W
2700K	6728lm	58W	116lm/W
2700K	9718lm	86W	113lm/W
3000K	3402lm	27W	126lm/W
3000K	5412lm	44W	123lm/W
3000K	7308lm	58W	126lm/W
3000K	10578lm	86W	123lm/W
4000K	3672lm	27W	136lm/W
4000K	5852lm	44W	133lm/W
4000K	7888lm	58W	136lm/W
4000K	11438lm	86W	133lm/W

## Photometric light distribution

Type 1

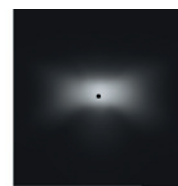
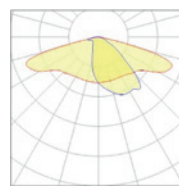

Type 2

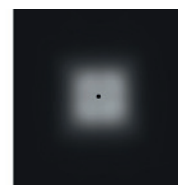
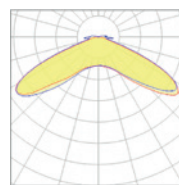

Type 3

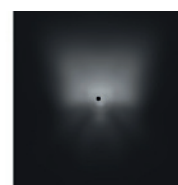
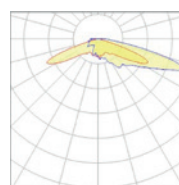

Type 6

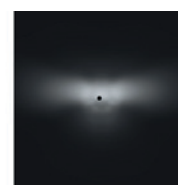
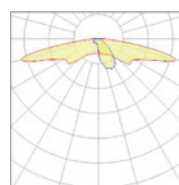

Type 9

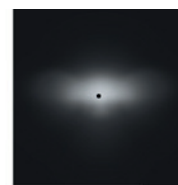
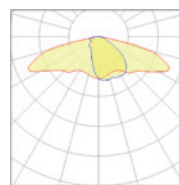

Type 12

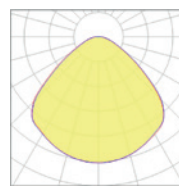

Type 13

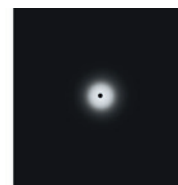
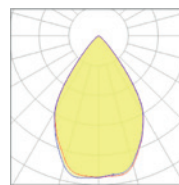

Type 14

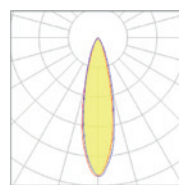

**Materials.** "ArchiMet" has launched its own production of seamless steel conical production line by induction heating. Laser-cut door with a special lock. Hot-Galvanized. Pole thickness 5mm. The luminaire is made of die-cast aluminium.

**Finishes.** The standard colors are Apex Grey and Apex Black that are obtained from a chromatic combination, which has been developed after a long aesthetic research. Power coating for luminaire and liquid for the post.



